

**NUX**



**LOOP CORE**  
DELUXE

Owner's Manual

## WARNING

To reduce the risk of fire or electric shock, do not expose this appliance to rain or moisture.

## CAUTION

This equipment has been tested and found to comply with the limits for a Class B digital device pursuant to Part 15 of FCC Rules. Operation is subject to the following two conditions: (1) This device may not cause harmful interference, and (2) this device must accept any interference received, including interference that may cause undesired operation.



The lightning symbol within a triangle means, “Electrical caution!” It indicates the presence of information about operating voltage and potential risks of electrical shock.



The exclamation point within a triangle means, “Caution!” Please read the information next to all caution signs.

Introduction.....	02
Features.....	02
Product Interface.....	03
About Battery.....	06
Connections.....	07
Power ON/OFF.....	12
Operation Instructions.....	13
Specification.....	23

## Introduction

### Welcome to Loop core deluxe

Thank you for choosing the NUX Loop Core Deluxe Pedal! As an upgraded version of the original NUX Loop Core, Loop Core Deluxe allows you to record and create music phases and play back as loops! Whether you practice, compose, or play live gigs, you will get inspired by the well-considered functions of Loop Core Deluxe.

Please take the time to read this manual carefully to get the most out of the unit. We recommend that you keep the manual at hand for future reference.

### Features:

- Record and overdub as many layers as you need.
- Up to 8 Hours recording time.
- 99 user memories.
- Built-in rhythm tracks with 40 patterns, TAP Tempo function.
- Optimized drum machine frequency compensation function for 1 x12 guitar amplifier.
- Cab simulation function.
- Buffer function to compensated signal attenuation.
- Change the playback tempo of your recorded phrases without changing the key.
- Switching phrases without latency.
- Extensional pedal (optional) for more control.
- Import and backup phrases with PC.
- True-Bypass.
- 24Bit Loop Pedal with drum machine.

## Product Interface

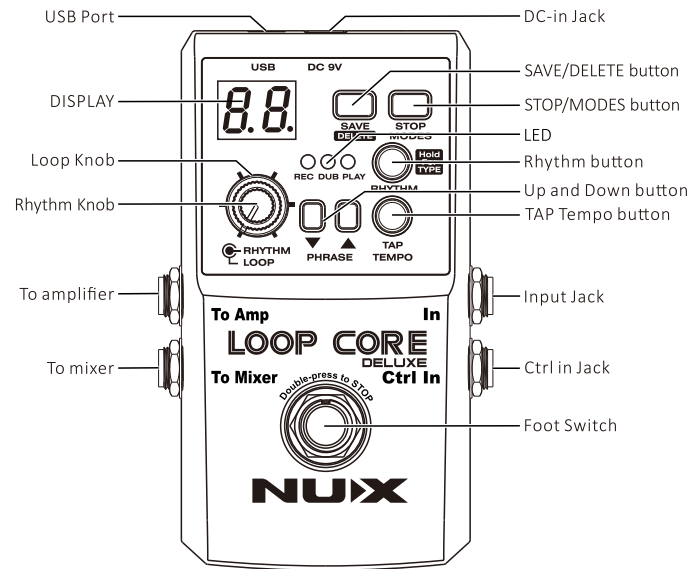

## Product Interface

---

### Display

It indicates the memories and rhythm number and other setting information.

### Loop knob

To adjust the playback volume level of the recorded audio.

### Rhythm knob

To adjust the volume level of the internal rhythm tracks.

### SAVE/DELETE button

To save the current phrase or delete the phrase in current memory.

### STOP/MODES button

To select the way you want to stop during playback after you press pedal to stop.

### RHYTHM button

This is for turning on/off the rhythm or selecting rhythm patterns. (Press this button before power on the device can let you to active the presets between application 3 (F 3) and application 4 (F 4). (P12, P13)

### LED indicator

REC: The red light indicates that you are recording.  
DUB: The orange light indicates that you are overdubbing.  
PLAY: The green light indicates that it's during playback of current phase.  
During overdubbing, both DUB and Play will light up.

## Product Interface

---

### TAP TEMPO button

Press this several times in time to set the tempo of rhythm. This can change the playback speed of a saved loop.

### Up and Down button

These decrement or increment the number shown in the display.

### Foot Switch

To record, overdub, playback, and you also press this pedal to stop, undo/redo and clear recording. (Please see below instruction for details)

### USB Port

Connect the Loop Core deluxe to your PC with a mini USB cable to import or backup audio data.

### DC-in Jack

Loop Core deluxe requires 9V DC/300mA with

negative tip. Use the power supply with identical specifications. (i.e. Optional NUX ACD-008A)

### Input Jack

This is a mono input. Plug your guitar or other instruments to this jack

### Ctrl In Jack

This is for connecting extensional pedals to stop playback, clear a phrase, switching memories, or do Tap tempo. (Please see below instruction for details)

### To Amp Out

This output the signal to your guitar amp.

### To Mixer

This output the signal to your mixer.

## About Battery

1 piece of 9V (6LR61) is supplied with the unit for testing purpose only. When battery is running out, the sound of unit gets distort. If this happens, please replace with new battery. To avoid non-necessary energy consumption, please unplug output jacks. We highly recommend you to choose NUX ACD-008A power adapter as the unit's power consumption is relatively high.

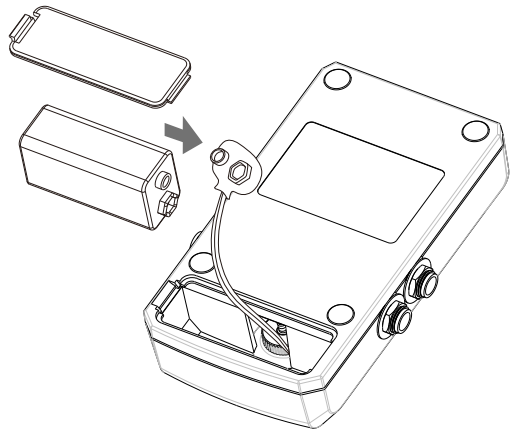

### NOTICE:

When you see “**L**” sign is blinking on the display, it means that the battery is running low and you should get a battery for it.

## Connections

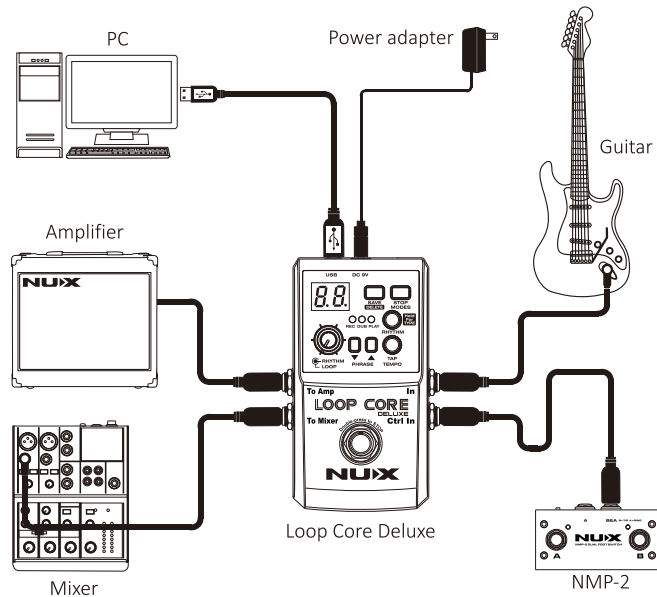

## Connections

Here we've listed 4 possible applications of Loop Core deluxe.

### Application 1:

Direct output to guitar amplifier It is the most common way how guitar players uses loop pedal. If you're connecting Loop core deluxe to a 1 x 12 guitar amplifier, we'd suggest you turn on frequency compensation function. (Press Save/Delete button before power on the device to turn it on or off)

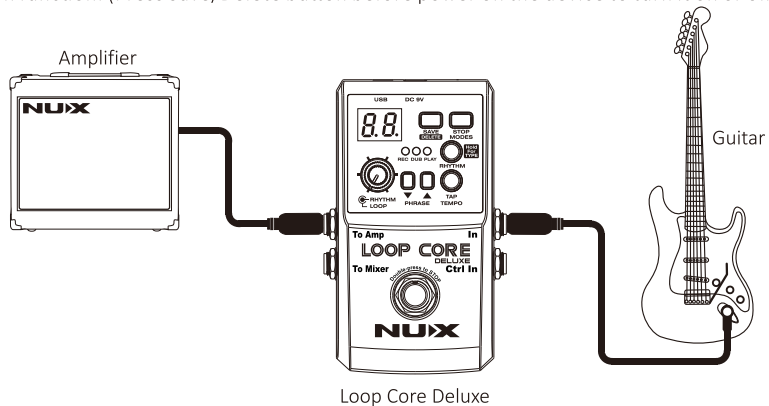

## Connections

### Application 2:

ONLY output to mixer, soundcard or full range speakers. Please turn on frequency compensation function to get a guitar sound with cab simulation tone.

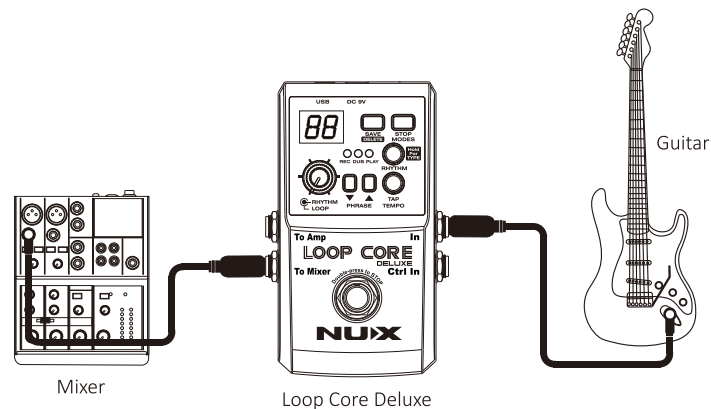

## Connections

### Application 3 (To Amp output guitar signal, To mixer output drum machine)

When using Loop Core Deluxe as the below situation, it will detect the type of devices connected.

Original guitar tone and loop phase will output to guitar amplifier while drum machine sound output to mixer.

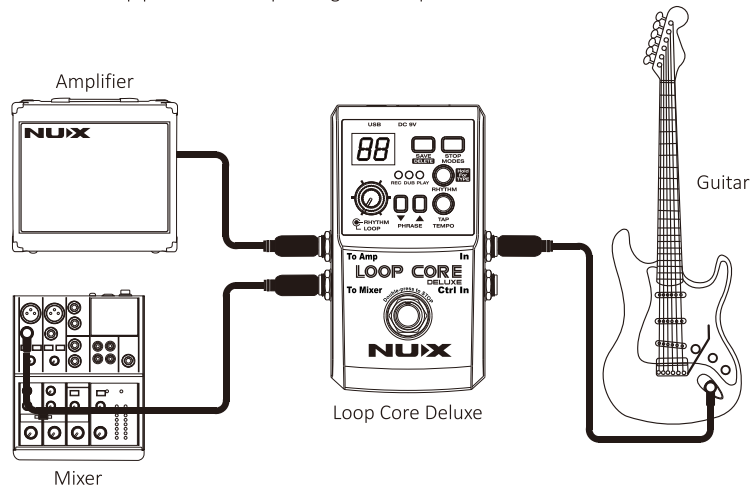

## Connections

### Application 4 (Both jack output guitar sound and drum machine sound)

Use 2 outputs simultaneously, connect Loop Core Deluxe to mixer via the stereo channel. When both outputs are connected to mixer, stereo sound comes from Amp out and Mixer out. We'd suggest you turn on frequency compensation function to get a better sound. (Press Save/Delete button before power on the device to turn it on or off)

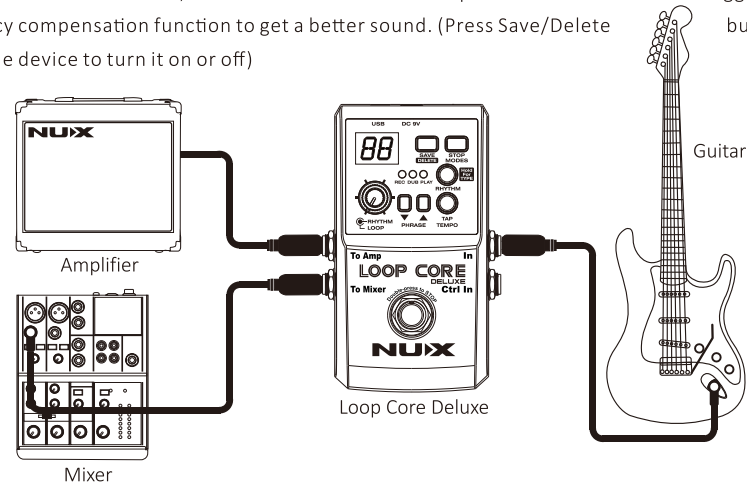

## Power ON/OFF

When running the unit on battery power, insert a plug into the OUT L jack will automatically switch the unit on. To prevent malfunction or damage to speakers or other devices, always turn down the volume, and turn off the power on all devices before any connections. Once the connections have been completed, turn on power to your various device in the order specified. By turning on device in the wrong order, you risk causing malfunction and/or damage to speakers and other devices.

When powering up: Turn on the power to your guitar amp last.

When powering down: Turn off the power to your guitar amp first.

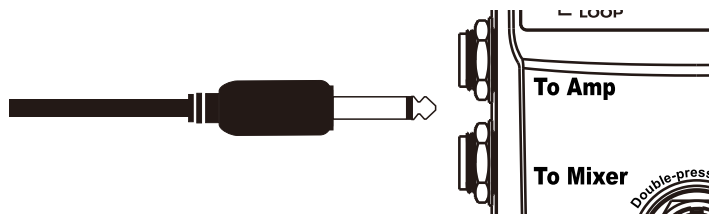

## Operation Instructions

### 1.To Record and Creat a Loop Phrase

#### 1.1 Normal Recording Mode(Default)

1.1.1 Select a empty memory location by pressing the Up and Down arrows.The display shows the current memory number. A dot at the down right corner of the display means the current memory number already has data saved. If there is no dot, it means the current memory number has no data, and you can start to create a new loop and save it in this memory location.

1.1.2 RECORD: Press the pedal to start to record a loop.

1.1.3 OVERDUB: After a loop was recorded, you can record overdubs on it. Each time you press the pedal, the sequence is: Rec – Play – Overdub.

**NOTE:** You can change this sequence to: Record – Overdub – Play by following this:

While holding down the pedal, turn on the power by inserting DC jack and plug a cable in OUT L jack. The display will show “rd” or “rP”, you can select either one by pressing the arrow buttons, and press the pedal once again to confirm.

“rd” for Record – Overdub – Play.  
“rP” for Record – Play – Overdub.

**NOTE:** To overdub on the current phrase. Loop Core Deluxe requires that the total remaining recording time must be longer than the time of current phrase. If the DUB LED light keeps blinking after you overdub, it means you cannot overdub under such status.



## Operation Instructions

---

1.1.4 STOP: During playback or overdubbing, double -press the pedal (press the pedal twice within 1 sec) to stop.

### 1.2 Auto Recording Mode

You can temporary set the Loop Core Deluxe to Auto Recording mode by following below steps:

1.2.1 Under an empty memory slot, press and hold STOP MODE button for 2 sec, “**Ar**” will be blinking on the display, press STOP MODE button again within 2 sec to change it to “**AR**” to enable Auto Recording mode.

1.2.2 Under this mode, the first time you press the pedal will enter recording standby status, and the REC LED will be blinking. It automatically

starts recording as soon as it detects input sound signal from AUX In or Input jack.

1.2.3 Overdubbing and playback are the same as normal recording mode.

**NOTE:** Changing to Auto Recording mode only temporary functions for the current memory location. Switching to next memory number will go back to Normal Recording mode, which is the default mode for Loop Core Deluxe.

### 1.3 Undo/Redo/Clear

**UNDO** During overdubbing or playback, you can hold down the pedal for 2 sec to undo (cancel) the most recent overdubbing.

## Operation Instructions

---

**REDO** During playback, press and hold the pedal for 2 sec can restore the overdubbing that you have just canceled.

\* Redo is Only for restoring overdubbing. There will be a little dot displayed in the middle of the two digits to indicate that you have data that can be restored.

**CLEAR** You can clear all recording data in this memory by holding the pedal down for 2 sec while stopped. (Already saved data will not be cleared this way, which is different from DELETE(see 1.8)

### 1.4 Stop Modes

Loop Core Deluxe has three stop modes that you can choose to finish the playback.

1.4.1 Before start playing a loop or during playback, you can press STOP MODES buttons to select the way you want the loop to end after you double-press the pedal.

“**St**”: instantly stops.

“**FR**”: stop at the ending of this loop.

“**FR**”: fade out and stop in 10sec.

1.4.2 If you choose “**FR**” or “**FR**”, after you double-press the pedal during playback, the PLAY LED will start blinking until it finally stops. If you still want the loop to end instantly during the time when the PLAY LED is blinking, just quickly press the pedal once again.

## Operation Instructions

---

### 1.5 Switching Memory Numbers/Loops

You can press Up and DOWN buttons to switch memory numbers/loops, or using optional extensional pedal (see 3 ).

During playback, if you switch to another loop, the number of the chosen phrase will start blink, and when the current loop reaches its end, the chosen loop will start playing. The transition has NO GAP, so it is perfect for creating a complete backing track that has verse and chorus!!

### 1.6 Save a Loop to Memory

Once you have created a music loop, you can save it to memory. You can save up to 99 memories. Each memory can be as long as you want until it reaches the memory limit. Loop core deluxe is equipped with 8GB memory,

Maximum recording time is about 8 hours.

1.6.1 Short press SAVE button and you will see the memory number and “**SR**” will be blinking on the display in turn.

1.6.2 Press Up or Down to choose an empty memory location (the down right corner of the display has no dot), and press SAVE again to confirm the storage. Or, you can press any button other than SAVE and UP/DOWN to abandon saving.

1.6.3 All the data including recordings, stop mode, tempo and the selected rhythm pattern will be saved. But recording mode will not be saved. Auto Recording mode can only be temporary set (see 1.2).

## Operation Instructions

---

**NOTE:** You cannot save to a memory location that already has data. During step 1.6.2, if you press UP or DOWN button and the next memory number already has data, it will lead you to the closest empty memory location.

### 1.7 Copy a Loop Phrase

You may want to copy a saved loop to another memory location by following below steps:

1.7.1 Choose the memory loop that you want to copy.

1.7.2 Short press SAVE/DELETE button and you will see the memory number on the display start blinking.

1.7.3 Press Up or Down to choose an empty

memory location (the down right corner of the display has no dot), and press SAVE/DELETE again to confirm the storage.

**NOTE:** If the remaining memory is not enough for copying the chosen loop, the display will show “**FU**” .

### 1.8 Delete a Memory

1.8.1 Press and hold the SAVE/DELETE button for two second, you will see “**DL**.” blinking on the display.

1.8.2 Press SAVE/DELETE once again to confirm deleting. Or, you can press any button other than SAVE/DELETE to abandon deleting.

1.8.3 All the data including recordings, stop mode, tempo and the selected rhythm pattern will be deleted.

## Operation Instructions

### 2. Rhythm tracks

Loop Core deluxe has built-in rhythm tracks that with 40 patterns, ranging from metronome click to drum tracks that cover various music styles. You can use the rhythm to guide your recording, or even after you finishing recording, you can turn on the rhythm tracks, and it will smartly immediately find your beat and follow!

2.1 Press RHYTHM or double press TAP TEMPO button to turn on the rhythm. The default sound is metronome click. The rhythm button blinks to indicate the tempo. If you start the rhythm after the loop has been recorded, the Loop Core will automatically detect the tempo of the loop.

2.2 TAP TEMPO button lights up to indicate that you can use this to set tempo. If this button does

not light up, it means tap tempo is not possible in such status, i.e. during recording or overdubbing.

2.3 Long press TAP TEMPO button to switch time signature in between 4/4 and 3/4 beat.

2.4 Press and hold RHYTHM button for 2 sec, and you will see the pattern number blinking on the display.

2.5 Use UP and down buttons to choose your favorite patterns.

2.6 Use TAP TEMPO button to set your desired tempo.

2.7 Rhythm types of Loop Core deluxe:

4/4 Beat List	
01	Metronome 4/4
02	Rock1
03	Rock2
04	Rock3
05	60S
06	Blues1
07	Blues2
08	Country1
09	Cumbia
10	Reggae
11	Jam
12	Jazz1
13	Native
14	Indie Rock
15	Pop1
16	Pop2
17	Pop3
18	Punk1
19	Punk2
20	Punk3

## Operation Instructions

21	Metal1
22	Metal2
23	Metal3
24	R&B
25	Straight1
26	Straight2
27	Dance House
28	Dance House01
29	Latin1
30	Latin2
3/4 Beat List	
01	Metronome3/4
02	Begin
03	Blues3/4
04	Arena3/4
05	Ballad3/4
06	Cricle3/4
07	Groove3/4
08	Jazz3/4
09	Motown3/4
10	Rock3/4

## Operation Instructions

---

### 3. Using Extensional Control Pedals

You can plug in an extensional control pedal to the Ctrl In Jack, i.e. NUX NMP-2(Optional) to hand more hand-free controls during live performance:

3.1 Plug in the NMP-2 to Ctrl in jack on loop core deluxe with the foot-switch of NMP-2 NOT pressed for at least 1 second, so that the Loop Core Deluxe can recognize the pedal.

3.2 Stop: Short press foot switch A of NMP-2 once to stop during recording, overdubbing and playback. Same as double-press the pedal of Loop Core Deluxe.

3.3 Tap Tempo: Press NMP-2(Switch A) several times in time to set the tempo while stops.

3.4 Clear Loop: Press and hold the NMP-2(Switch

A) will clear all the recordings that have not saved.

3.5 You can also plug in the NMP-2 through its Jack B&A to Ctrl in, footswitch B/A can be used to switch recording phases (Up and down).

### 4. USB Connection

Turn on the power of Loop Core deluxe by connecting the power adapter and plug a cable to "To Amp" or "To Mixer", Connect a USB cable between Loop Core Deluxe and your PC. The display of Loop Core Deluxe will show "U" when it is connected successfully. Now you can import WAV files to Loop Core Deluxe or backup the recording phrases from Loop Core to your PC:

4.1 To import a WAV file to Loop Core Deluxe.

## Operation Instructions

---

4.1.1 Click and open the removable disk of Loop Core Deluxe, and open the "LOOPER24" folder.

4.1.2 Open the WAV folder, and there will be 99 folders for 99 memory numbers: "W001" "W002"... "W099". Choose one empty folder that you want to import a WAV file to. For example: folder "W031".

4.1.3 Copy the WAV file from your computer to the folder "W031", and rename this WAV file to "W031.wav"

4.1.4 This WAV file is imported successfully and can be played as a loop in memory number 31 in Loop Core.

Note: Loop Core Deluxe accept WAV file that is 24-bit, Stereo 44.1kHz.

4.2 To back up and recover phrases from Loop Core Deluxe to your PC.

4.2.1 Copy the "LOOPER24" folder to your PC to back up.

4.2.2 Copy the "LOOPER24" folder from your PC to replace the "LOOPER24" folder in Loop Core Deluxe to recover.

**Warning:** Do NOT power off or unplug the device when it's transferring data.

### 5. Formatting Loop Core Deluxe

In case you want to reset the Loop Core Deluxe back to factory setting, you can format the Loop Core Deluxe by the following steps:

5.1 Power on the Loop Core deluxe while pressing down the foot switch until the display

## Operation Instructions

---

show “ r d ” or “ r P ”.

5.2 Press and hold UP or Down button for 2 sec until the display shows “FD”.

5.3 Press the pedal once again to confirm formatting. Or, press any other buttons to abandon formatting.

### WARNING:

1. Formatting the NUX Loop Core Deluxe will wipe away all recordings from it and set everything to factory settings. Please backup all your data before you format the device.

2. Please do now power off your device until the formatting process is completed.

## Specification

---

Sampling rate: 44.1 KHz

A/D converter: 24 bit

Signal Processing: 24 bit

Frequency response: 20Hz-20 KHz

Noise Level:-98dBu

Dynamic range: 101db

Power consumption: 65mA-70mA

Input: Mono

Output: To Amplifier, To Mixer

Display: LED & LED segment displays

Power: 6LR61 battery (9V) or 9V negative tip power adapter

Dimensions: 122(L) x72(W) x47(H) mm

Weight: 270g

\*Specifications are subject to change without prior notice

Accessories: Cables User Manual 9V Battery

### CE mark for European Harmonized Standards

CE Mark which is attached to our company's products of Battery means the product is in full conformity with the harmonized standard(s) EN 61000-6-3:2007+A1:2011 & EN 61000-6-1:2007 Under the Council Directive 2004/108/EC on Electromagnetic Compatibility.

©2017 Cherub Technology-All rights reserved. No part of this publication may be reproduced in any form without prior written permission of Cherub Technology.



[www.nuxefx.com](http://www.nuxefx.com)

Made in China